

# Analysis of Harmonic Distortion Generated by PWM Motor Drives

Vladimir Sousa, Hernán Hernández

Faculty of Engineering

Universidad de la Costa (CUC)

Calle 58 No.55-66, Barranquilla, Colombia

email: vsousa1@cuc.edu.co, hhernand16@cuc.edu.co

Enrique C. Quispe

Energy and Mechanical Department

Universidad Autónoma de Occidente (UAO)

Calle 25 No.115-85, Cali, Colombia

email: ecquispe@uao.edu.co

Julio R. Gómez, Percy R. Viego

Faculty of Engineering

Universidad de Cienfuegos (UCf)

Carretera a Rodas km 4, Cienfuegos, Cuba

email: jgomez@ucf.edu.cu, pviego@ucf.edu.cu

**Abstract**—This paper evaluates the harmonic distortion generated by PWM motor drives in an electrical industrial system of a wheat flour mill company. For this, a comparative study between two industrial circuits connected at the same point of common coupling with similar characteristics of load and transformers is presented. The difference is that one circuit has PWM motor drives and the other does not have them. In the study, a practical method based on the statistical characterization of the total harmonic distortion of voltage (THDV) and current (THDI), individual voltage distortion (IVD), individual current distortion (ICD) and K-Factor is applied. As result, it was observed that PWM motor drives generated harmonics voltage mainly of fifth and seventh order with values that exceed limits established by standards in both circuits. In the work is also demonstrated that in the analysis of harmonics is necessary to consider various parameters and not only one.

**Keywords**— *electrical industrial system, harmonic distortion; PWM motor drives; harmonic statistical analysis*

## I. INTRODUCTION

The problems associated with power system harmonics are reflected in the increase in the use of non-linear loads in new technologies. It is estimated that more than 50% of the European and US loads will contain power electronics in the near future [1].

In industry, there is a widespread use of motors supplies from several types of solid-state adjustable voltage–frequency controllers (VSDs) [2]. Among these, the pulse width modulation (PWM) motor drives are the most common used because of several advantages compared to various other VSDs [3]. High reliability, robustness, low cost, an efficient and fast induction motors control in many automated industrial applications and the possibility of saving up to 60% of energy, are the main reasons for the extensive use of PWM motor drives [4]-[6]. However, the principle of operation of PWM motor drives and its electronic composition, produce distortion

on voltage and current waves with abundant high-frequency harmonics [7].

Harmonic voltages increase magnetic core losses in motors and transformers while harmonic currents increase losses in winding and structure of most of the components of electrical systems. These losses cause temperature rise and life-span reduction [8].

Some investigations have studied the effects of harmonics produced by PWM motor drives or by others non-linear devices on electrical industrial systems elements, focusing on motors [1], [2], [9]-[17], transformers [8], [18]-[21], and capacitor banks [22], [23].

The evaluation of power quality in electrical industrial systems is important to identify the presence of high levels of harmonics and take actions to reduce its effects on motors, capacitors, transformers and others devices. In [18], a study of energy quality in two-distribution transformers of two buildings of a university is carried out. In [8], the power quality in a distribution transformer that feeds a residential power grid is analysed. In [24], the quality of the energy and the harmonics in an electrical circuit with personal computers are characterized. The impact of sugar centrifugal process on power quality of a sugar industry electrical grid is studied in [25].

This paper evaluates the harmonic distortion generated by PWM motor drives and the impact on the power quality in an electrical industrial system of a wheat flour mill company. The major contribution is the analysis of actual data of a wheat flour mill, considering the consequence of includes PWM motor drives. In Section II, the method, harmonic distortion parameters, statistical tools, and evaluation criteria used, are described. In Section III, results and discussions of evaluation of harmonics distortion generated by PWM motor drives in two industrial circuits are presented. One circuit has PWM motor drives and the other one does not include it.

## II. MATERIALS AND METHOD

### A. Harmonic Distortion Parameters

The applied method is based on characterizing the harmonics generated by the PWM motor drives from the harmonic distortion parameters: total harmonic distortion of voltage (THDV), total harmonic distortion of current (THDI), individual voltage distortion (IVD), individual current distortion (ICD) and K-Factor. The parameters THDV, THDI, IVD and ICD are defined in the IEEE Std-1159-2009 standard [26] as following:

$$\text{THDV} = \sqrt{\frac{\sum_{k=2}^{\infty} V_k^2}{V_1^2}} \cdot 100 \quad (1)$$

$$\text{THDI} = \sqrt{\frac{\sum_{k=2}^{\infty} I_k^2}{I_1^2}} \cdot 100 \quad (2)$$

$$\text{IVD} = \frac{V_k}{V_1} \cdot 100 \quad (3)$$

$$\text{ICD} = \frac{I_k}{I_1} \cdot 100 \quad (4)$$

where, the subscript k represents harmonics order and subscript 1 represents fundamental component.

In 69 kV and below, with the ratio among the maximum short-circuits current ( $I_{sc}$ ) and the maximum demand load current ( $I_L$ ) between 100 and 1000 at PCC; the limits of THDV, THDI, IVD and ICD are presented in Table I [26].

TABLE I. LIMITS OF THDV, THDI, IVD AND ICD

Parameter	Limits (%)
THDV	5
THDI	15
IVD	3
ICD	12

K-Factor is a harmonic distortion parameter that considers the harmonics current effect on transformer losses and it is defined as [23]:

$$\text{K-Factor} = \sum_{k=1}^{\infty} \left( \frac{I_k}{I_1} \right)^2 \cdot k^2 \quad (5)$$

The additional heating due to the square of the per unit harmonic load currents and the square of the harmonic order is the characteristic that dominates premature breakdown of transformers supplying non-sinusoidal currents, due to abnormal winding temperature rise [20]. Because the K-Factor considers frequency, it is the most accurate and the most useful

method to estimate nonlinear load harmonic content for the specification of dry-type power distribution transformers [21].

### B. Statistical Tools for Harmonics Analysis

Field measurements indicate that voltage and harmonics current are time-variant due to continuous changes in system load conditions [26]. Variations often occur rapidly in a non-deterministic or random form, so is necessary to use statistical tools to quantify harmonics level [27]. The average value, the probability distribution function and the correlation between THDV and THDI, are statistical tools used in the applied method.

Average value of THDV, THDI, IVD, ICD and K-Factor, are a reference to compare the level of harmonics between areas and with standards limits [19], [26]. Because of the variation in harmonics behaviour, the average value is not enough, so the use of probability distribution function is recommended [27]. The probability distribution function gives the summation of all the intervals in which the variable exceeds a certain level, e.g. the limit set by standards [27]. This tool can be applied with the help of the graphical user interface "dfttool" of Matlab.

The correlation between THDV and THDI allows analysing both, the influence of harmonics current generated by nonlinear loads on the voltage waveform of feeders and the influence of distorted voltage waveform on the current waveform in circuits [27].

### C. Method

The steps of the applied method for the evaluation of harmonic distortion generated by PWM motor drives on electrical industrial system are:

1. Selecting of two areas fed from two transformers with equal properties connected to the same point of common coupling (PCC). Areas have motors with similar features and operating regime. In one of the area, motors use PWM motor drives, while in the other area does not have PWM.
2. Measurement with power quality analyser from the secondary of transformer, the electrical parameters, mainly the following harmonic distortion parameters: THDV, THDI, IVD, ICD and K-Factor. The recommended monitoring period is defined as a complete working cycle [26].
3. Statistical analysis of the behaviour of THDV, THDI, IVD, ICD and K-Factor.
4. Evaluation of the harmonic distortion parameters considering standards.

## III. RESULTS AND DISCUSSION

### A. Case Study

The effects of harmonics generated by PWM motor drives were studied in two areas of a wheat flour mill company. In both areas, all the milling process is carried out.

Two equal independent dry-type power distribution transformers of 1500 kVA supply energy to both areas. The two circuits are close to each other and are connected to the same PCC. The total load of each area is similar, with 1203 kW of installed power, and 130 induction motors from 0.18 kW to 110 kW each one.

The main differences in both areas are following:

- In Area A, there are 50 PWM motor drives of six and twelve pulses with a total capacity of 159.6 kW installed in the main motors of the milling process. Each mill receives the feedstock from a PWM motor drive system of 0.75 kW. In addition, there is a turbine-motor of 110 kW, fed by a PWM motor drive. Others small motors employ PWM motor drives. Table II shows the general characteristics of the PWM motor drives.
- In Area B, PWM motor drives are not used. The mills receive the feedstock from a mechanical drive. The turbine-motor of 110 kW and other small motors are fed directly from the network.

TABLE II. CHARACTERISTICS OF PWM MOTOR DRIVES

QUANTITY	POWER (kW)	MANUFACTURER	PULSES
1	110	SIEMENS	12
24	0.75	ALLEN-BRADLEY POWER FLEX	6
16	0.75	ALTIVAR- SCHNEIDER ELECTRIC	6
5	2.23	SEW	12
4	2.1	POWER FLEX 4M	6
<b>TOTAL</b>	<b>159.6</b>		

For the analysis, the electrical parameters were measured with two identical power quality and energy analysers Fluke 435 II. The instruments registered the electrical parameters during the same time in the secondary of each transformer for one week. Fig.1 shows the general electrical scheme of two areas. In figure, Mm represents the mills, Mf the motors that supply the feedstock to mills and M represents the rest of motors including a turbine-motor.

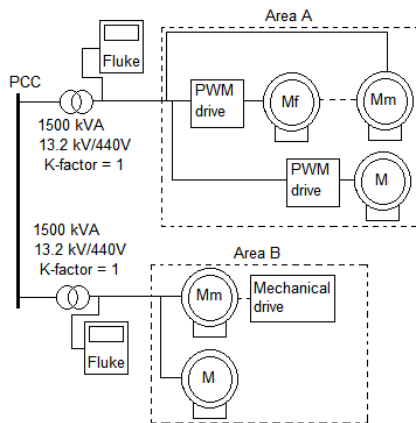

Fig.1. Scheme of two areas

### B. Behavior of Harmonic Distortion Parameters

Fig.2. shows the behaviour of THDI and THDV during the registered period in areas A and B. Fig. 2 (a) shows that in the circuit with PWM motor drives connected (Area A), the THDI is greater than the circuit without PWM motor drives (Area B).

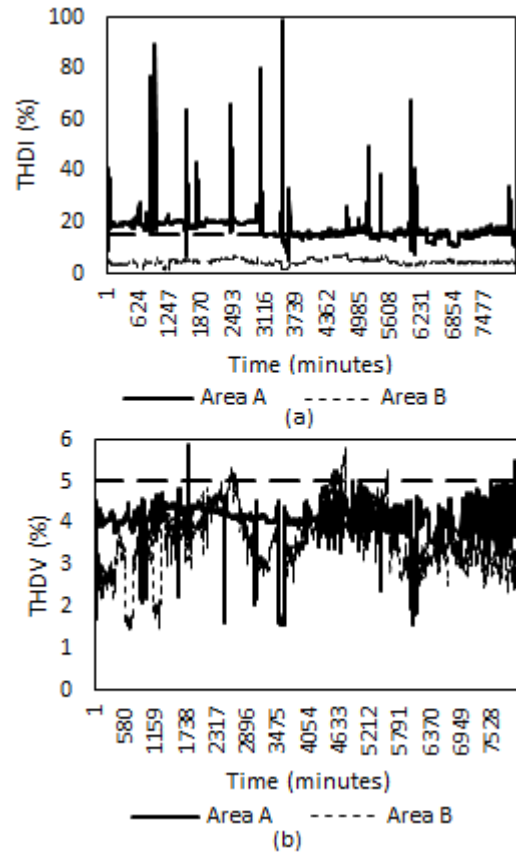

Fig.2. Variation of (a) THDI and (b) THDV in both areas

The THDI values in Area A, exceed 15%, the limit established by the IEEE Std 1159-2009 [26]. Fig. 2 (b) shows that in both circuits the THDV has a variable behaviour around similar values. In both cases, the THDV is near and less than 5%; only some points exceed this limit.

This demonstrates that distortion on the current waveform in a circuit is a direct consequence of PWM motor drives. In addition, the THDV caused by nonlinear loads in Area A, affects the circuits connected to the same feeder, such as in Area B, which does not have non-linear loads.

Fig.3 presents the graphs of probability distribution function corresponding to registers of THDI and THDV previously observed.

In Fig.3 (a), probability distribution function allows specifying that in Area A, 81.74% of data are above 15%, limit established by standard [26] for THDI. In Area B, all values of THDI are lower than 15%. In Fig.3 (b) is observed that in Area B, only 4.56% of data exceeds the limit of 5% set by [26] for THDV; in Area A, this value is not reached. Nevertheless, taken 4% as a reference of THDV, it is observed that in Area A, in general, the THDV is greater than in Area B throughout all period, although is below the limit of 5%.

It is important to note that although in Area A the THDV does not exceed the limits set by [26], the THDI generated by PWM motor drives has high values that exceed the established limits.

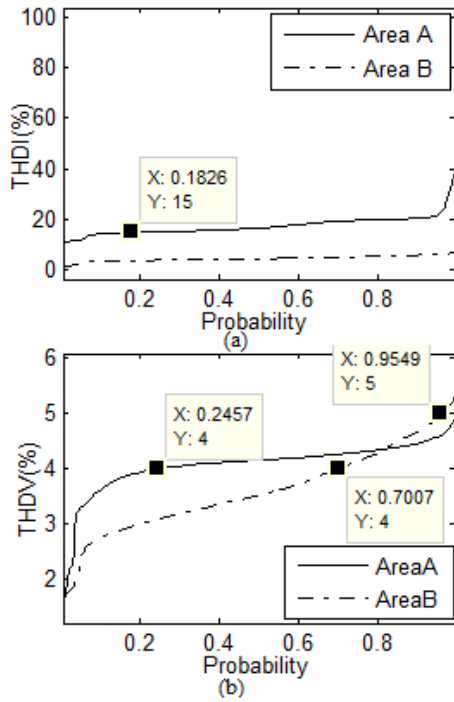

Fig.3. Probability distribution function of (a) THDI and (b) THDV in both areas

To determine the relationship between THDI and THDV, a scatter plot for each area with the corresponding linear fit was obtained. This is shown in Fig. 4.

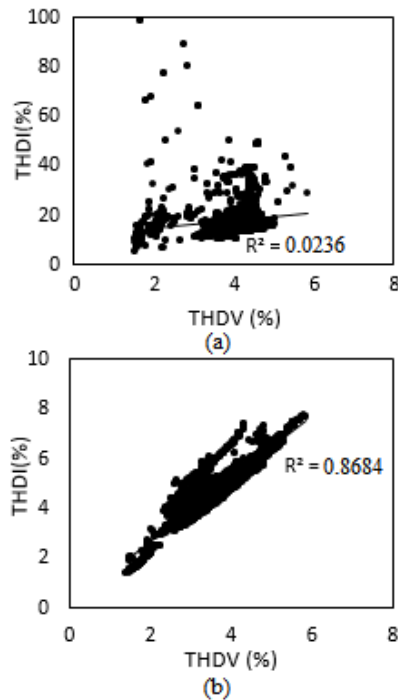

Fig.4. Scatter plot of THDI as function of THDV, (a) area A, (b) area B

In the circuit of Area A, the correlation coefficient is only 0.0236, indicating that there is no simple relationship between THDI and THDV. This is because the THDI is caused by the combination of PWM motor drives of the circuit and the effect of THDV of network. In the circuit of Area B, the correlation coefficient is 0.8684. In this circuit, there are not nonlinear elements; therefore, the high correlation indicates that the THDI is a direct consequence of THDV of the network due fundamentally to the current distortion generated by PWM motor drives of the circuit of Area A.

The analysis of the individual harmonics is important because each level of harmonic according to its sequence has a different impact on the elements and devices of electrical circuits [12], [26]. The average of measurements of IVD and ICD in both areas is presented in Fig. 5 in bar graphs. In the circuit of Area A, because of the presence of PWM motor drives, the ICD of each harmonic level is higher than the circuit of Area B, where there are not PWM motor drives. In the circuit of Area A, the average of ICD of fifth-order harmonic exceeds the limit of 12% set by [26].

Concerning IVD, an affection is observed in both circuits with harmonics of fifth and seventh order mainly. Voltage harmonics of fifth order in Area A, are superior to those in Area B, while in Area B, voltage harmonics of seventh order are superior to those in Area A. In Area B, the average of IVD of the seventh order exceeds the limit of 3% set by [26].

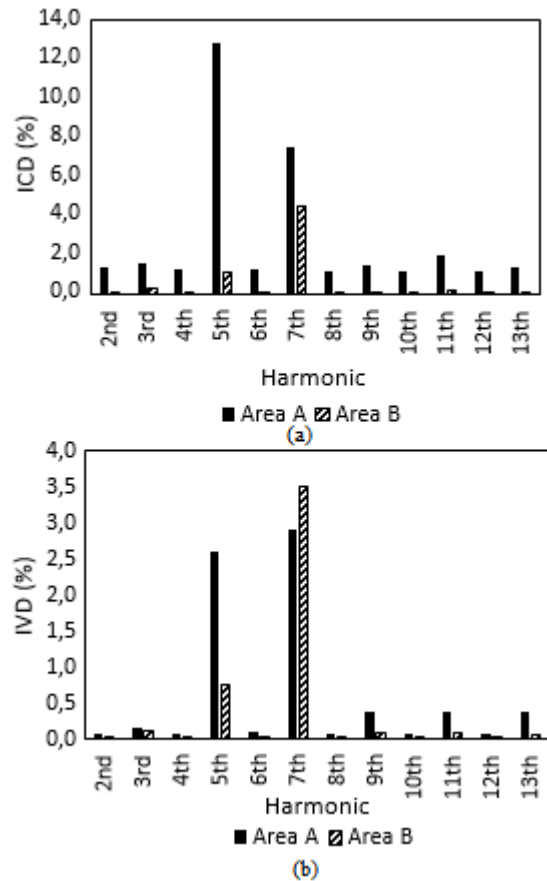

Fig.5. Average of ICD and IVD in both areas

The figure shows that in both circuits, there are current and voltage harmonics from second to thirteenth order. Nevertheless, theoretically, six-pulse converters should generate harmonics of  $(6k \pm 1)$  order [26], therefore, should not be presented even harmonics or third-order harmonics. However, in [28], [29] it demonstrates that in some cases may appear new even and odd harmonics referred to as non-characteristic or atypical harmonics. This is due to several defects in inverters such as: asymmetry, inaccuracy in thyristor firing times and imperfect switching time and filtering [29].

To observing the behaviour of IVD and ICD of the most significant harmonics, Fig. 6 shows the graphs of probability distribution function of harmonics of fifth and seventh order.

Fig 6 (a) confirms that ICD of fifth-order harmonics are the most significant and circulate in the circuit of Area A. The 53.08% of registers exceed the limit of 12% set by [26]. In the circuit of Area B, only 3.69% of ICD of seventh-order harmonics exceed the limit.

In Fig 6 (b), is observed that IVD most significant are of fifth-order harmonics in the circuit of Area A, and seventh-order harmonics in both circuits. In Area A, 22.03% of data corresponding to fifth-order harmonics and 43.48% of data of IVD of seventh-order harmonics, exceed the limit of 3% set by [26] for IVD. Area B is the most affected by harmonics of seventh order with 75.86% of the data exceeding the limit of the standard.

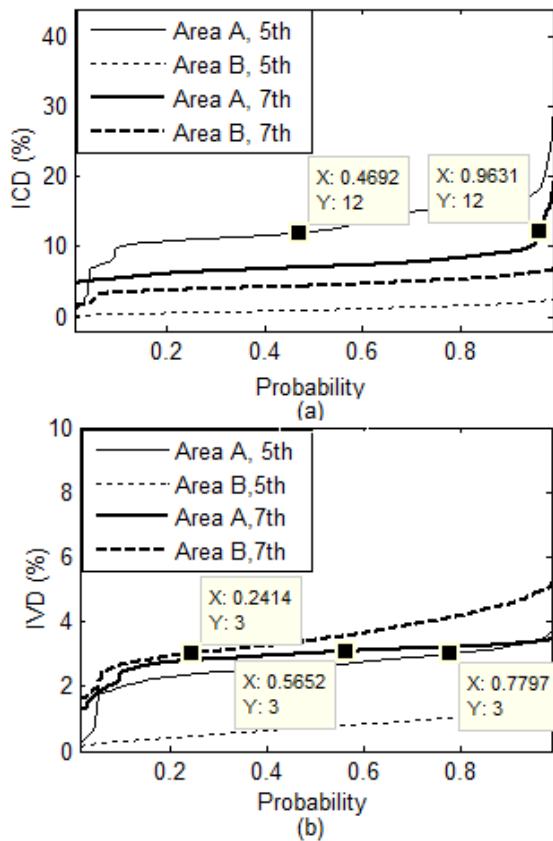

Fig.6. Probability distribution function of (a) ICD and (b) IVD in both areas

Is noteworthy that although the values of THD were below the limit of [26], the values of IVD exceed the corresponding established limit.

Low-frequency harmonics of the fifth and seventh order generated by PWM motor drives are very harmful, because the impedance of the system for these harmonics is low, and facilitated the flow of harmonic currents. For that reason researches prioritizes the study based on low order harmonic [8], [9], [11], [12].

According to [22], [23], the values achieved of IVD and ICD in harmonics of fifth and seventh order generated by PWM motor drives, would be sufficient to cause resonance and multiplication of the harmonic currents and voltages and affect the capacitors. In [9], [11], [12] it is shown that with the behaviour of IVD in the two areas, losses and heating in motors is increased. Therefore, its efficiency and life expectative is reduced.

The other parameter directly related to the effect of harmonic distortion on transformers is the K-Factor. Fig. 7 presents the K-Factor in the two areas and its comparison with the design value (K-Factor=1) of used transformers.

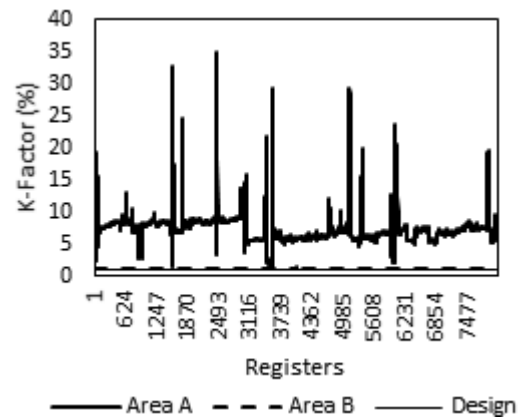

Fig.7. K-Factor in areas A and B

According to (5), the K-Factor depends directly on the harmonic current. For this reason, K-Factor in the transformer of Area A, is greater than in transformer of Area B. In transformer of Area B, K-Factor value is close to its design value. However, in the transformer of Area A, K-Factor values are about seven, well above of design value. This could cause an additional heating and reduction in life due to harmonics in this transformer [19]-[21].

#### IV. Conclusions

The investigations carried out so far and the results of this work demonstrate that although there are standards establishing the allowable level of harmonics in the network and have been developed new technology for its mitigation, harmonic distortion in electrical networks generated by PWM motor drives remain an ongoing problem.

The analysis of harmonics in industrial electrical systems should be performed taking into account various parameters of harmonic distortion and not only one. In the case study analysed, it was observed that the THDV was below the

established limits by IEEE Std 1159-2009. However, the THDI, IVD, ICD and K-Factor, revealed the existence of harmonic problems that causing damages on electrical devices.

#### REFERENCES

- [1] S. R. Movahed, S. O. Mirzamani, A. Rajabi, H. Daneshvar, "Estimation of insulation life of inverter-fed induction motors," in *Proc. Conf. Power Electronic & Drive Systems & Technologies Conference (PEDSTC)*, pp. 335-339, Feb. 2010.
- [2] G. K. Singh, "A research survey of induction motor operation with non-sinusoidal supply wave forms," *Elect. Power Syst. Res.*, vol. 75, no. 2, pp. 200-213, 2005.
- [3] G. Suresh, H. A. Toliyat and A. Abur, "Analysis of the effect of feeder cable on the stator winding voltage stress in a PWM induction motor drive," in *Proc. Electrical Insulation Conference, 1997, and Electrical Manufacturing & Coil Winding Conference*, pp. 407-412, Sep. 1997.
- [4] M. C. Di Piazza and M. Pucci. "Techniques for efficiency improvement in PWM motor drives," *Elect. Power Syst. Res.*, vol. 136, pp. 270-280, 2016.
- [5] M. Chirindo, M. A. Khan and P. S. Barendse, "Considerations for nonintrusive efficiency estimation of inverter-fed induction motors," *IEEE Trans. Ind. Electron.*, vol. 63, no. 2, pp. 741-749, Feb. 2016.
- [6] C. J. R. Kriel, H. P. R. Joubert and J. H. Marais, "The influence of variable speed drives on electric motor operating temperatures," in *Proc. Industrial and Commercial Use of Energy Conference (ICUE)*, pp. 1-6, Aug. 2013.
- [7] R. Mayuri., N. R. Sinnou and K. Ilango, "Eddy current loss modelling in transformer iron losses operated by PWM inverter," in *Proc. Power Electronics, Drives and Energy Systems (PEDES) & 2010 Power India, 2010 Joint International*, pp. 1-5, Dec. 2010.
- [8] M. Digałowski, K. Najdenkoski and G. Rafałowski, "Impact of current high order harmonic to core losses of three-phase distribution transformer," in *Proc. EUROCON*, pp. 1531-1535, Jul. 2013.
- [9] H. Oraee, "A quantitative approach to estimate the life expectancy of motor insulation systems," *IEEE Trans. Dielect. and Elect. Insul.*, vol. 7, no. 6, pp. 790-796, Dec. 2000.
- [10] A. Inan and F. Attar, "The life expectancy analysis for an electric motor due to harmonics," in *Proc. Electrotechnical Conference, MELECON 98.*, vol.2, pp. 997-999, May. 1998.
- [11] J. P. G. de Abreu and A. E. Emanuel, "Induction motor thermal aging caused by voltage distortion and imbalance: loss of useful life and its estimated cost," in *Proc. Industrial and Commercial Power Systems Technical Conference*, pp. 105-114, May. 2001.
- [12] V. S. Santos, P. R. V. Felipe, J. R. G. Sarduy, N. A. Lemozy, A. Jurado and E. C. Quispe, "Procedure for determining induction motor efficiency working under distorted grid voltages," *IEEE Trans. Energy Conv.*, vol. 30, no. 1, pp. 331-339, Mar. 2015.
- [13] P. Donolo, G. Bossio, C. De Angelo, G. Garcia, and M. Donolo, "Voltage unbalance and harmonic distortion effects on induction motor power, torque and vibrations," *Elect. Power Syst. Res.*, vol. 140, no. 1, pp. 866-873, Nov. 2016.
- [14] Y. Wang, W. Liu, Z. Chen and B. Bai, "Calculation of high frequency bearing currents of PWM inverter-fed VF induction motor," in *Proc. 2014 International Power Electronics and Application Conference and Exposition*, Shanghai, pp. 1428-1433, Nov. 2014.
- [15] Y. Wang, B. Bai and W. F. Liu, "Research on discharging bearing currents of PWM inverter-fed variable frequency induction motor," in *Proc. Electrical Machines and Systems (ICEMS)*, pp. 2945-2949, 2014.
- [16] B. Zhu, B. Bai and H. He, "Effects of the inverter parameters on the eddy current losses in induction motor fed by PWM inverter," in *Proc. Electrical Machines and Systems ICEMS 2008*. pp. 4240-4243, Oct. 2008.
- [17] A. Strandt, J. Hu and L. Wei, "No-load power losses and motor overheating effects versus PWM switching frequencies," in *Proc. Renewable Energy Research and Application (ICRERA)*, pp. 280-283, Oct. 2014.
- [18] D. M. Said, K. M. Nor and M. S. Majid, "Analysis of distribution transformer losses and life expectancy using measured harmonic data," in *Proc. 14th International Conference on Harmonics and Quality of Power - ICHQP 2010*, pp. 1-6, 2010.
- [19] G. W. Massey, "Estimation methods for power system harmonic effects on power distribution transformers," *IEEE Trans. Ind. Appl.*, vol. 30, no. 2, pp. 485-489, Mar/Apr. 1994.
- [20] M. T. Bishop, J. F. Baranowski, D. Heath and S. J. Benna, "Evaluating harmonic-induced transformer heating," *IEEE Trans. Power Deliv.*, vol. 11, no. 1, pp. 305-311, Jan. 1996.
- [21] L. W. Pierce, "Transformer design and application considerations for nonsinusoidal load currents," *IEEE Trans. Ind. Appl.*, vol. 32, no. 3, pp. 633-645, May/Jun. 1996.
- [22] W. Chen and Z. Cheng, "An experimental study of the damaging effects of harmonics in power networks on the capacitor dielectrics," in *Proc. Second International Conference on Properties and Applications*, vol.2, pp. 645-648, Sep. 1988.
- [23] C. Boonseng, C. Chompoo-Inwai, V. Kinnares, K. Nakawiwat and P. Apiratikul, "Failure analysis of dielectric of low voltage power capacitors due to related harmonic resonance effects," in *Proc. Power Engineering Society Winter Meeting, 2001. IEEE*, Columbus, vol.3, pp. 1003-1008, Feb. 2001.
- [24] M.J.H. Rawa, D.W.P. Thomas, M. Sumner, "Power quality monitoring and simulation of a personal computer based on IEEE 1459-2010", *Proc. Int. Conf. International Symposium on Electromagnetic Compatibility*, pp. 671-675, Sep. 2013.
- [25] P. Aramwanid, I. Boonyaroonate, "Power quality impact study and analysis of electrical power efficacy in sugar industry", *Proc. Int. Conf. Electrical Engineering/Electronics, Computer, Telecommunications and Information Technology*, pp.1-4, Jun. 2015.
- [26] "IEEE Recommended practices and requirements for harmonic control in electrical power systems", *IEEE Standard 519*, 1993.
- [27] Y. Baghzouz, R.F. Burch, A. Capasso, A. Cavallini, A.E. Emanuel, M. Halpin, A. Imece, A. Ludbrook, G. Montanari, K.J. Olejniczak, P. Ribeiro, S. Rios-Marcuello, L. Tang, R. Thaliyam and P. Verde, "Time-varying harmonics. I. Characterizing measured data", *IEEE Trans. Pow. Deliv.*, vol. 13, no. 3, pp. 938-944, Jul. 1998.
- [28] A. E. Emanuel, J. A. Orr, "Six-pulse converter atypical harmonics caused by second harmonic voltage", *Proc. Int. Conf. 10th International Conference on Harmonics and Quality of Power*, pp. 340-346, Oct. 2002.
- [29] C. Collombet, J. M. Lupin, J. Schonek, "Harmonics disturbances in networks, and their treatment", *Cahier Technique Merlin Gerin.*, vol. 1, no. 152, pp. 28, 1999.